

AQUAFLEX™

Actuator Valve



5-POSITION REMOTE DISCONNECT AMI-READY VALVE

Remotely disconnect, reconnect, or reduce flow to your service locations from the comfort and safety of your office

Model: AquaFlex™ AVS Valve

AQUAFLEX™ AVS AMI-READY VALVE is an IP68 rated remote disconnect ball valve designed with the flexibility to integrate with any existing AMI platform.

FEATURE HIGHLIGHTS

- Remotely disconnect, reconnect, or reduce flow to service locations using a compatible 3rd party AMI system
- 5-position Ball Valve
- Male-Female Swivel Nut Valve Body
- Small Mechanical Form Factor
- IP68 Rated for Submersion
- 20-year Battery Life

PRODUCT DESCRIPTION

AMI Compatible

Each AquaFlex includes a 3' serial cable designed with industry standard Geospace Hydroconn® AMR3 (Nicor) or AMR4 (Itron compatible) connections, compatible with most existing AMI endpoints.

Five Valve Positions

AquaFlex supports five valve positions (OPEN, CLOSED, REDUCED FLOW 1, 2, 3). Position Reduced 1 is configured for trickle flow at 1-2GPM (60psi) for utilities that do not wish to fully disconnect water service. Reduced flow positions 2 and 3 can be customized to deliver additional reduced flow rates for conservation compliance, or other applications.

Swivel Nut

Each residential size valve is designed with NPSM threaded male and female swivel nut (1/2", 3/4", 1"). This allows easy installation directly to meter. Each valve body is NSF61/lead-free certified with a brass body and stainless steel ball.

Simple Servicing

The AquaFlex actuator can be serviced separately from the valve body, enabling you to pre-install a valve body without a controller until valve control is needed, or service them independently.

MATERIALS & SPECIFICATIONS

Valve Positions	Open, Closed, Reduced-1 (1-2GPM), Reduced-2 (custom), Reduced-3 (custom)
Valve Body Material	Brass Body with Stainless Steel Ball
Case Material	Estaloc 59300
Communication Interface	AMR4 Standard (Itron compatible) or AMR3 optional (Nicor)
Max Operating Pressure	150psi
Operating Temperature	-22°F-140°F (-30°C-60°C)
Min/Max Water Temperature	32.1°F (0.5°C) Max Water Temp: 140°F (60°C)
Ratings/Certifications	NSF61/Leadfree, IP68
Power	3.6V C-Cell Lithium Metal Battery
Battery Life	20 years (based on 2 position changes per month)
Warranty	20-year limited warranty (10 year full replacement, 10 year prorated)

DIMENSIONS

Model	Valve Bore Size (in.)	Connection Size (in.)	Threads	Valve Lay Length	Height	Width
AVS 1/2"	1/2"	3/4" NPSM	M/F Swivel	2.30"	5.31"	3.52"
AVS 3/4"	3/4"	1" NPSM	M/F Swivel	2.30"	5.55"	3.52"
AVS 1"	1"	1.25" NPSM	M/F Swivel	2.87"	5.95"	3.52"

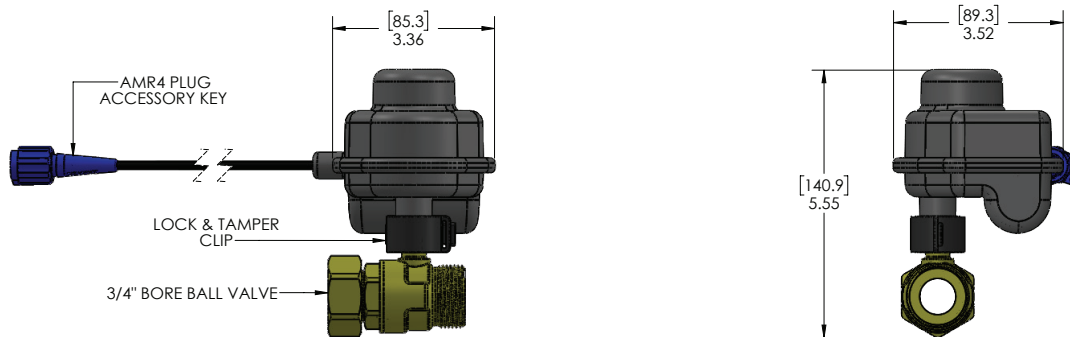

Specifications are subject to change at the sole discretion of Aquana, LLC.